



AUTONAUTIC
the compass specialist

PRODUCT DATASHEET

COMPASS

C12/110-0010
FLUSH-MOUNT

SKU C12/110-0010

Flush Mount Wheelmark/SOLAS compass

C12/110-0010 FLUSH MOUNT



OVERVIEW

The C12/110 flush mount compass is one of the most popular compasses in our range and the best option for tenders and motor boats. Its special design of the inner gimballed system allows the installation on inclined panels without losing the horizontality of the dial.

The stylish design ensures that the compass looks at home on pleasure craft yet the rugged construction allows commercial applications.

And with features such as corrosion-resistant materials and sealed construction to prevent water intrusion this compass provides reliable heading source for safe navigation at sea.

FEATURES

85mm canonical card

5° graduation

Anti-glare screen

12/24 V lighting

Powerful Directive Force Magnets for Fast Heading Lock-on

Individual MED/SOLAS certificate included

100% Repairable

Exclusive 5 years warranty

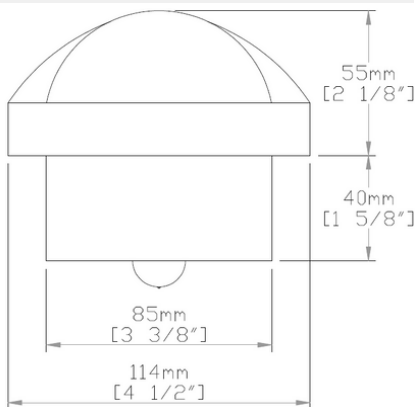

APPROVALS

Directive 2014/90/EC on marine equipment

ISO 25862:2019

ISO 9001 certified management system



SOLAS

**ISO
25862**

Click [here](#) to see EC
Type Examination
(Module B) Certificate

Member of CISQ Federation

 CERTIFIED MANAGEMENT SYSTEM
ISO 9001

www.autonauticinstrumental.com
 info@autonauticinstrumental.com
 Agricultura 22, El Masnou (08320), Barcelona
 +34 93 540 99 49

PRODUCT DATA SHEET



www.autonauticinstrumental.com
info@autonauticinstrumental.com

The world's lead specialist company in magnetic compasses